

# Activity 1. The Amazing Journey

My Name is:



Jannah



Jerusalem

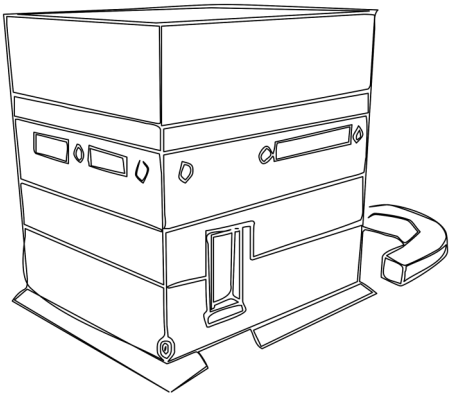

Makkah

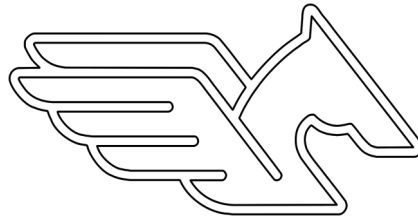

The Buraq is a special animal from Jannah which can travel as far as the eye can see with one single leap.

**Al-Isra wal-Miraj** was our Prophet Muhammad's amazing night journey. He travelled from **Makkah** to **Masjid Al-Aqsa** and then ascended up to the **heavens** before returning back to **Makkah!**



# Before the Journey Began...

**Al Isra wal Miraj took place during a time when our Prophet Muhammad ﷺ was facing great hardship and pain.**

## BULLY

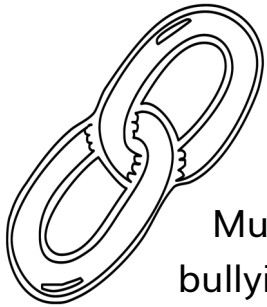

The people of Makkah were hard to the Muslims. They were bullying, hurting, and imprisoning the Muslims. Some of the Muslims even died!

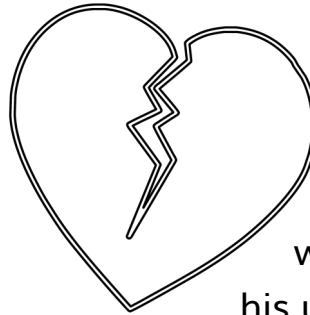

## SADNESS

Prophet Muhammad's ﷺ wife Khadija ﷺ and his uncle in the same year passed away. This was known as The Year of Sadness.



## TA'IF

Our Prophet ﷺ travelled to Ta'if to teach them about Islam. The leaders of Ta'if rejected the message and ordered some people to chase out and hurt him our Prophet ﷺ.



**It was during these hard times that Allah Taala showed His power and mercy to our Prophet Muhammad ﷺ by taking him on the most amazing and incredible journey of Al-Isra wal-Miraj.**



# WHERE ARE THEY GOING?

In the past, people travelled through the desert together as a 'caravan' with camels carrying their goods.

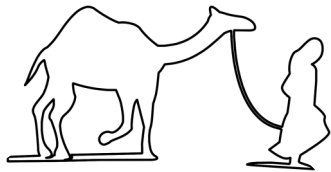

The camels were ideal for travelling through the hot dry desert but it took a long time to travel because camels are slow.

They were not as quick as the Buraq! **Can you do this Puzzle quicker than the Buraq?**

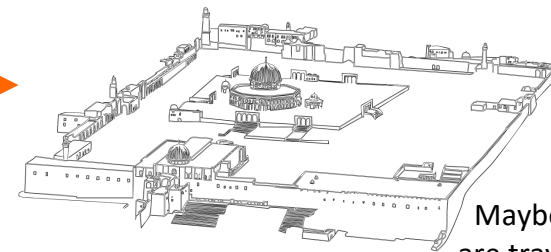
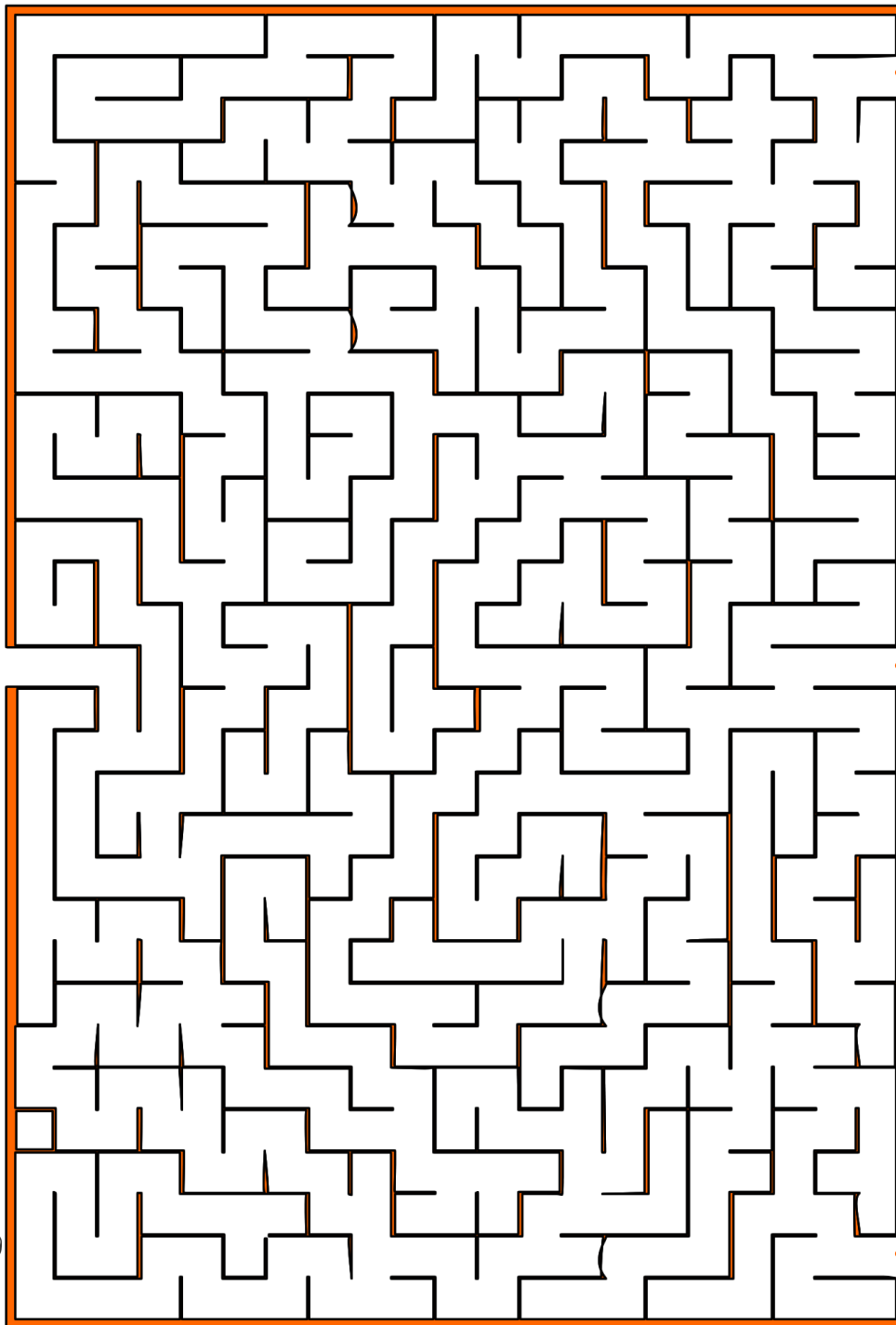

Maybe they are travelling to visit the beautiful Masjid al-Aqsa.



They may stop over in Madina for rest before they travel on.

They may even eat some delicious dates.

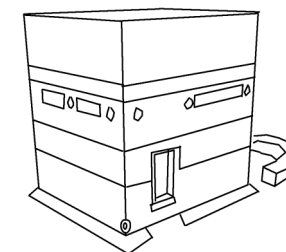

Are they travelling to Makkah? Maybe they want to perform Hajj or Umrah.

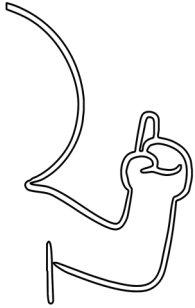

I would love to visit **Masjid Al-Aqsa**. Can you draw me a picture and tell me about it?

# Al Isra Wal Miraj

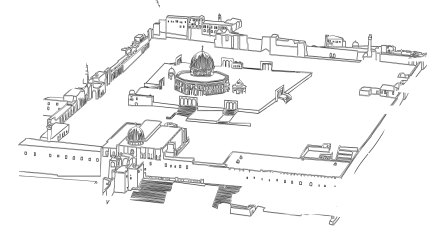

## About Masjid Al-Aqsa

On the journey of Al-Isra wal-Miraj, Prophet Muhammad ﷺ did and saw some wonderful things. This included



He visited Masjid Al-Aqsa, a place he loved very much.



He met Allah who gave him a wonderful gift of the five daily Salah.

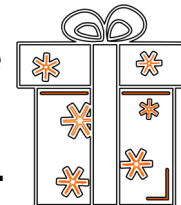

He met many prophets.





## Al-Isra wal Miraj

It had been a tough time for the Muslims in Makkah. They were suffering many difficulties and hardships. The people of Makkah were being particularly bad to them.

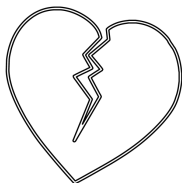

Prophet Muhammad ﷺ had also suffered some personal tragedy with the death of Khadija ؓ, his beloved wife and friend. His uncle, Abu Talib, who had provided him protection and support, had also passed away in the same year.

Our story begins with the Angel Jibrael ؑ waking up our Prophet Muhammad ﷺ. Jibrael ؑ took him to Masjid Al-Aqsa in Jerusalem.



Muhammad ﷺ travelled on the Buraq which was a special animal from Jannah.

They travelled to Masjid Al-Aqsa where our beloved Prophet ﷺ performed Salah with all of the prophets from the past. Our Prophet ﷺ was the Imam while all the prophets followed him.



After this miraculous meeting, Muhammad ﷺ continued the journey by ascending through the heavens. On the way, he met many prophets and the angels that guarded each heaven.



Passing the last heaven, they reached the Lote tree (Sidratul Muntaha). Prophet Muhammad ﷺ continued the journey on his own as Jibrael ؑ could not go any further.

Muhammad ﷺ spoke with Allah and was given a gift of the five daily Salah.



Initially, it was fifty Salah but on his return journey through the heavens, Musa ؑ advised him that fifty was too many for the people. He advised our Prophet ﷺ to go back to Allah ﷻ to have it reduced.

# 5

Our Prophet went back to Allah and the Salah was reduced to forty-five.

Again Musa ؑ advised our Prophet ﷺ to have the Salah reduced. This happened a number of times until it was reduced to five daily Salah.

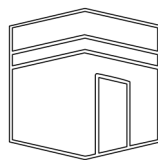

Prophet Muhammad ﷺ saw many sites on his journey through the heavens. He saw the people of Jannah and Jahannam.

He saw some of the people of Jahannam receiving punishment for the bad things they did.

On his return journey, Prophet Muhammad ﷺ travelled back to Makkah. He saw the caravans travelling to Makkah, their camels laden with goods to sell at the markets.

When Muhammad ﷺ returned, he told the people about this journey that he had made in only a short part of the night.

They were surprised and some even mocked Muhammad ﷺ about this journey.



They said that no one had travelled to Masjid Al-Aqsa so quickly, it would take many weeks not a small part of a night!

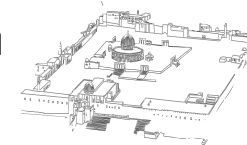

They asked him to describe Masjid Al-Aqsa. The Prophet Muhammad ﷺ described the Masjid Al-Aqsa in perfect detail.

He told them about the caravans that were coming to Makkah soon. He even described the content of one of the caravans.

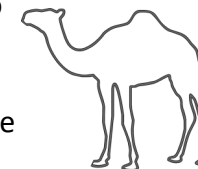

A few days later, when the caravans began to arrive, they were amazed because it was exactly as Muhammad ﷺ had described them.

# Activity 2. To Masjid Al-Aqsa

Al Isra is the Arabic word for the night journey. This was the miraculous journey made by Prophet Muhammad ﷺ from Makkah to Masjid Al-Aqsa in Jerusalem.

My Name is:

After a short journey of travel, they arrived in Masjid Al-Aqsa in Jerusalem.

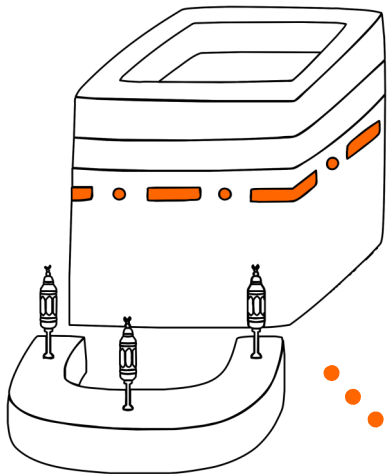
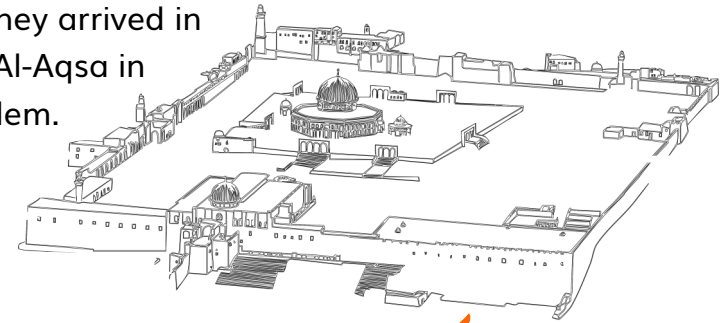

Prophet Muhammad ﷺ was sleeping near the Ka'bah in Umm Hani's house.

Angel Jibrael ﷺ came with the Buraq to take him on the journey.

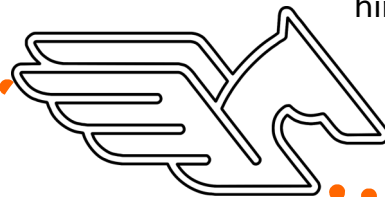

The Buraq travelled at a very fast speed.



# That Night in Makkah

Prophet Muhammad ﷺ was in Makkah when Angel Jibrael ﷺ and the Buraq came to take our Nabi Muhammad ﷺ on the night journey to Jerusalem.

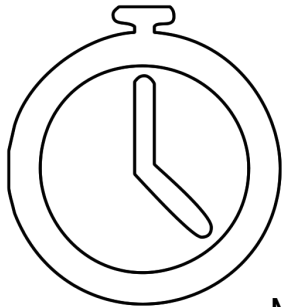

## WAKE UP

It was late at night when Prophet Muhammad ﷺ was sleeping when Jibrael ﷺ woke him up.



## WISDOM & FAITH

Angel Jibrael ﷺ took Prophet Muhammad ﷺ to the zam zam well and purified his heart, pouring Wisdom and Faith into it.

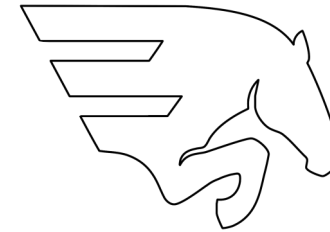

## AL-BURAQ

The Buraq is a beautiful animal from Jannah. It is white in colour and in size smaller than a horse. With one step it can travel as far as the eye can see.



The journey from Makkah to Jerusalem only took a very short time. The Buraq could travel vast distances in a very short time, it was unlike any animal on earth. Before long Prophet Muhammad ﷺ and Angel Jibrael ﷺ arrived at Masjid Al-Aqsa.



# WORD GAMES

1. How many facts can you remember about each word?

♥ Angel Jibrael ♥

♥ Zamzam ♥

♥ Purify ♥

♥ Buraq ♥

♥ Umm Hani ♥

♥ Jerusalem ♥

♥ Ka'bah ♥

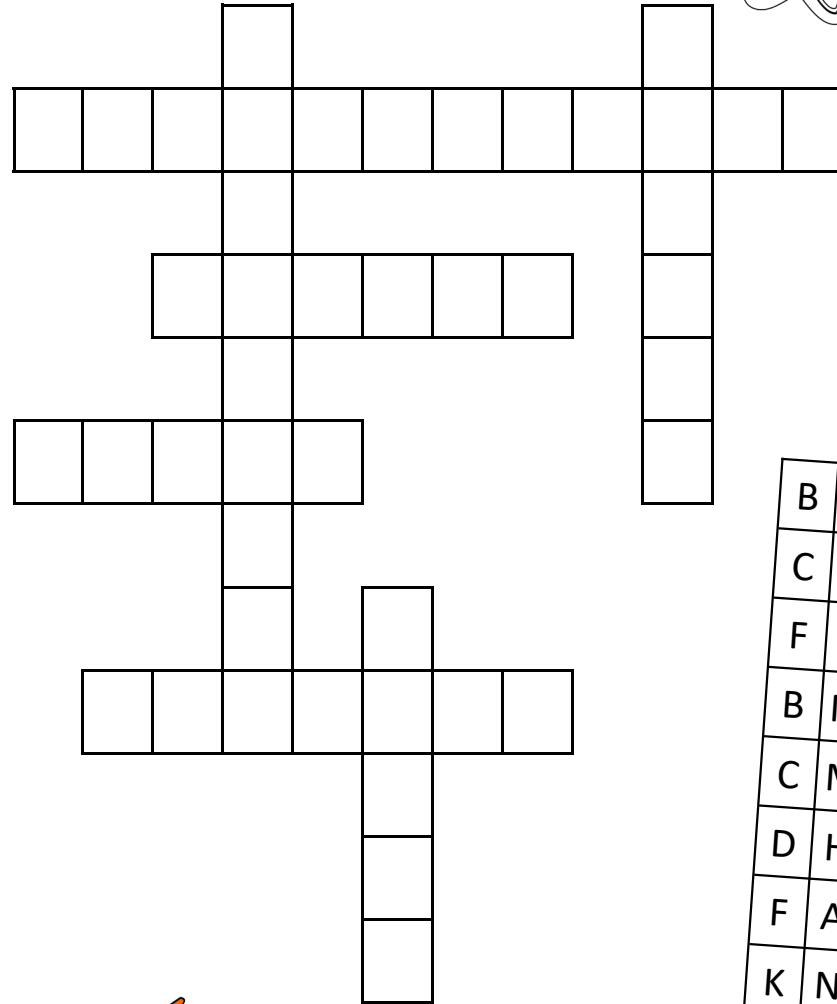

2. Fit The words into the Grid



The Buraq became nervous when Jibrael ﷺ reminded him that he had an esteemed guest on his back.



3. FIND THE WORDS

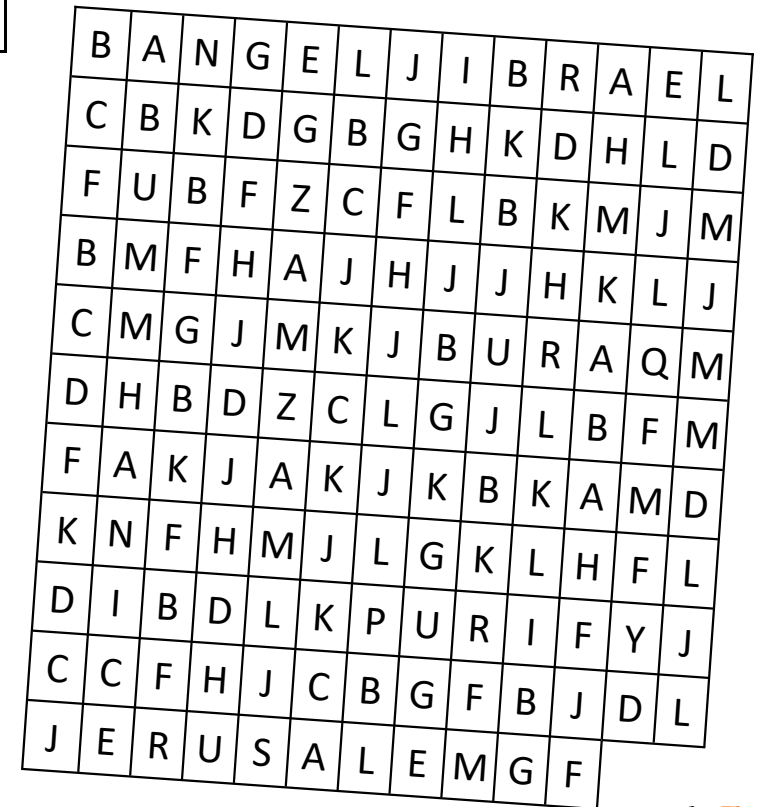

# Qibla to Qibla

FIND THE FASTEST AND SLOWEST ROUTE!

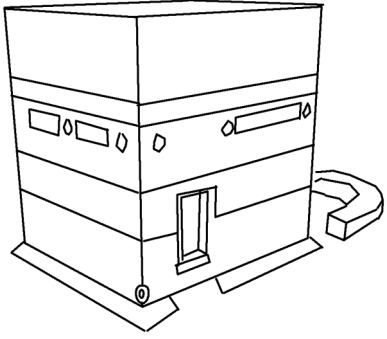

## KA'BAH FACTS

This was the first house built by Prophet Adam ﷺ so people could worship Allah.

Praying salah here has 100,000 times more reward.

This became the Qibla after the Hijra when the Muslims were in Madina.

The Ka'bah is the most important Masjid in Islam.

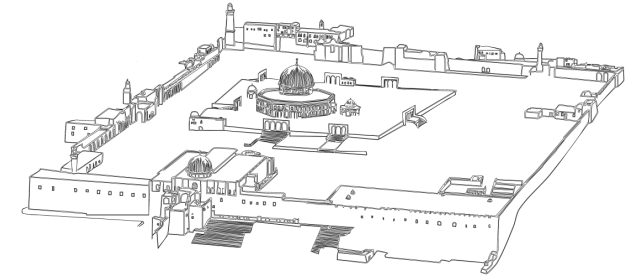
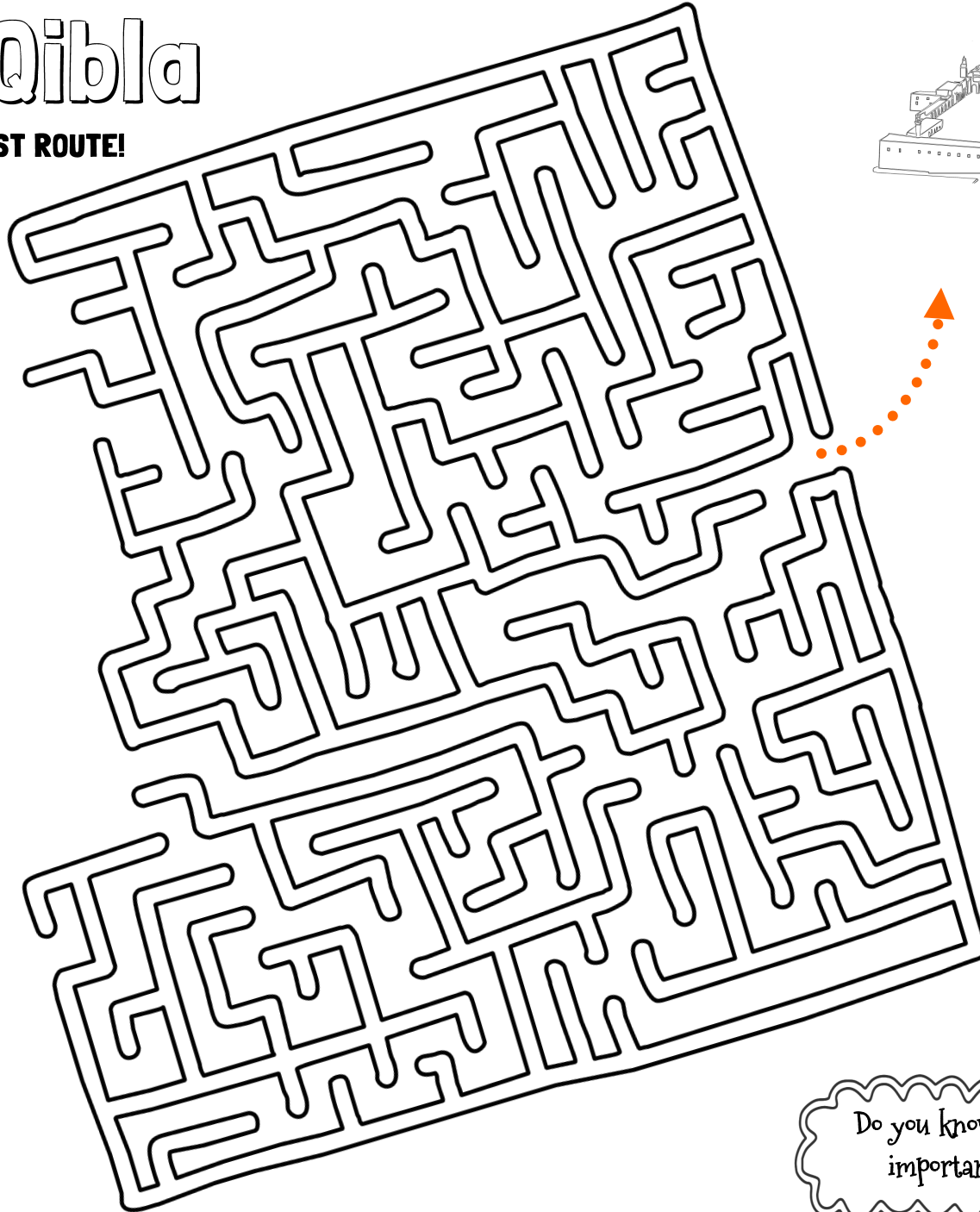

## AL-AQSA FACTS

Masjid Al-Aqsa is located in the sacred city of Jerusalem.

It was the second Masjid built by Prophet Adam ﷺ. It was built 40 years after the Ka'bah

Praying Salah here has 500 times more reward.

Masjid Al-Aqsa was the first Qibla. The direction of prayer.

Masjid Al-Aqsa is the third most important Masjid in Islam

Do you know what the second most important Masjid in Islam is?





## Al-Isra

One night, Prophet Muhammad ﷺ was sleeping in the house of Umm Hani. Her house was near the Ka'bah in Makkah. This was like any other normal night until Muhammad ﷺ was woken up by Angel Jibrael ﷺ.

Angel Jibrael ﷺ had been sent by Allah to bring Muhammad ﷺ on a long journey, travelling on an amazing animal called the Buraq.

But first, Angel Jibrael ﷺ took Muhammad ﷺ to the Zamzam Well and split open his chest, purified his heart by washing it with Zamzam.

This is not the first time, Angel Jibrael ﷺ had split open Muhammad's chest to purify his heart.

If you remember back to Muhammad ﷺ as a youngster staying with Halima Sadiyyah. The Angel had visited him during this time and also purified his heart.

The angel then filled his heart with Iman and wisdom before they started this amazing journey.

Prophet Muhammad ﷺ mounted the Buraq which was a white coloured animal, smaller than a horse. The Buraq was strutting so Jibrael ﷺ reminded him that he had an esteemed guest on his back. The Buraq immediately calmed down and began to sweat.

Soon they were on their journey through the night sky. With each step the Buraq took, it



travelled a distance as far as the eye could see. The Buraq was much faster than any animal that has ever lived on the Earth.

Normally, a journey to Jerusalem would take many weeks. It was a long and difficult journey. People

travelled together in groups called 'caravans'. They would use camels to carry their goods and belongings. Camel caravans were ideal for travelling through hot dry deserts.

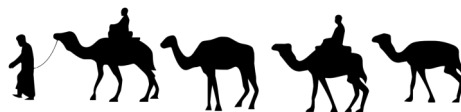

Before very long, Muhammad ﷺ arrived at Masjid Al-Aqsa and came off the Buraq. He tied the Buraq to a ring on the wall. This same ring was used by other prophets to tie their animals before they entered the Masjid.

The wall on which the Buraq was tied is now known as the Buraq Wall. Make sure to see it when you visit Masjid Al-Aqsa!

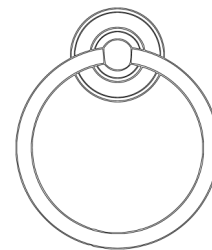

Prophet Muhammad ﷺ then proceeded to enter Masjid Al-Aqsa.

This was the first part of the miraculous journey, known as Al-Isra, the night journey.



Allah had collected all the prophets throughout history at Masjid Al-Aqsa. He had called them here to one of the most sacred places on Earth. Muhammad ﷺ would meet the prophets and lead them in Salah in Masjid Al-Aqsa.

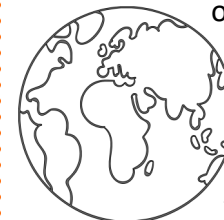

Why was this place, Masjid Al-Aqsa, so special? Why had Allah called all these prophets here? What was the purpose of Prophet Muhammad's amazing journey - Al-Isra wal-Miraj?

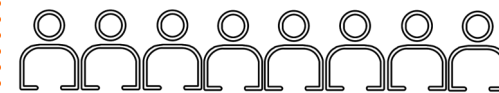

This is a story for next time, In Sha Allah.

# Activity 3. In Masjid Al-Aqsa

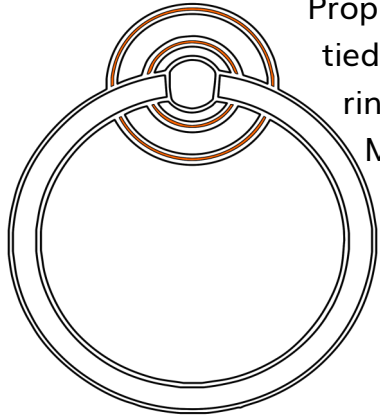

Prophet Muhammad ﷺ tied the Buraq to the ring on the wall of Masjid Al-Aqsa.

Prophet Muhammad ﷺ and Jibrael ؑ continued the journey to Jannah.

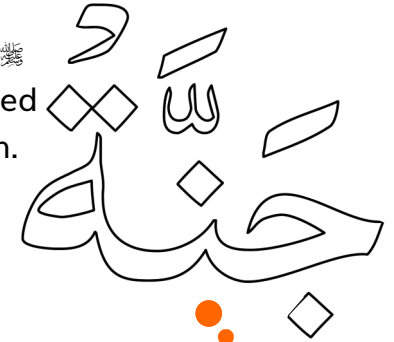

**In MASJID AL-AQSA,**  
Allah had collected all the prophets throughout history and brought them here for a special salah. They all prayed with prophet Muhammad ﷺ before he continued the journey to Jannah.

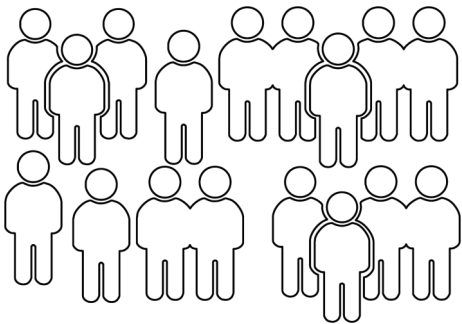

All the prophets were already gathered inside Masjid Al-Aqsa.

All the prophets prayed together.

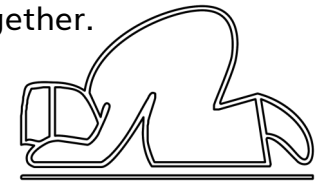

The call was made for Salah.

My Name is:



# The Prophets of Allah

One of the most amazing parts of the story is that Allah chose Masjid Al-Aqsa for all the prophets to gather at the same time to pray Salah together.



## THE BEST

The prophets are the best of people. Allah selected them

to teach the people about Islam. The prophets taught people to worship Allah alone; be good and helpful.



## ALL NATIONS

Every nation was sent a prophet.

Hadith tells us that about 124,000 prophets were sent.



## MUHAMMAD

Prophet Muhammad ﷺ was the Last and Final

Prophet. No more prophets will come after him. He is the final prophet and seal of prophethood.



All the prophets from history gathered in Masjid Al-Aqsa and the call for Salah was made. Prophet Muhammad ﷺ lead the Salah as imam and all the other prophets prayed behind him. After this amazing event, Prophet Muhammad ﷺ and Jibrael ﷺ continued their journey up towards Jannah.



# Land of the Prophets

Jerusalem is also known as **Al-Quds** (the Holy One). Many prophets have visited and lived in **Jerusalem**. Many prophets are buried in and around **Masjid Al-Aqsa**, this makes Jerusalem very special in the hearts of Muslims.



# AL-AQSA

Many prophets have a special connection to Masjid Al-Aqsa, let's learn about some of these prophets.

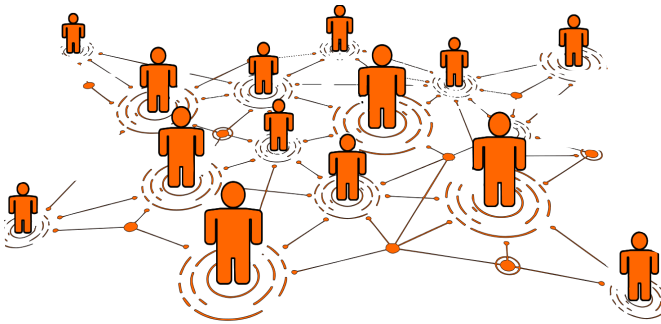

Masjid Al-Aqsa is a blessed place, our Prophet ﷺ told us: "There is not a single inch in Al-Aqsa where a prophet has not prayed or an angel stood" (Tirmidhi)

1. Un-jumble the letters to reveal the name of the Prophet

## JUMBLE

**RBMIAIH** = -----

**MUSLNIA** = -----

**MMHDAMAU** = -----

**SAI** = ---

**WUDDA** = -----

**HAAYY** = -----

**DMAA** = -----



2. What can you tell me about these prophet?

### ADAM

Prophet Adam ﷺ built Masjid Al-Aqsa for the first time. It was rebuilt and repaired many times after that.

### IBRAHIM

Prophet Ibrahim ﷺ and his second son Prophet Ishaq ﷺ, rebuilt Masjid Al-Aqsa.

### SULAIMAN

Prophet Sulaiman ﷺ was able to speak with animals. He finished rebuilding Masjid Al-Aqsa that His father Dawud ﷺ had started.

### ZAKARIYA

Prophet Zakariya ﷺ was the imam of Masjid Al-Aqsa. He had a son called Prophet Yahya ﷺ.

### ISA

It was in Masjid Al-Aqsa that Angel Jibrael ﷺ told Maryam ﷺ about the birth of Prophet Isa ﷺ.

### MUHAMMAD

Prophet Muhammad ﷺ went into the Seven heavens from Masjid Al-Aqsa.



## In Masjid Al-Aqsa

Prophet Muhammad ﷺ and Angel Jibrael عليه السلام had set off from Makkah on the Buraq. The journey to Masjid Al-Aqsa in Jerusalem had been very quick because the Buraq was so fast.

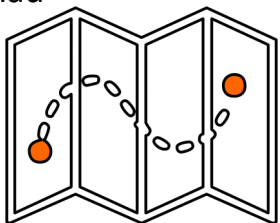

The Buraq could travel as far as the eye could see with one single step. It was a very quick journey, far quicker than



anything on earth. Definitely quicker than camels!

After arriving at Masjid Al-Aqsa, Prophet Muhammad ﷺ tied the Buraq to the ring on the wall of Masjid Al-Aqsa. This is the same ring that was used by other prophets.

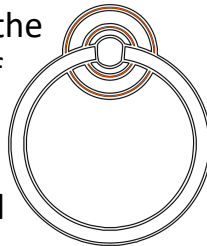

On entering the Masjid, Prophet Muhammad ﷺ saw all the prophets of the past gathered there. You can imagine what an amazing sight that was!



This is the first time in history that all the prophets were gathered together in one place at the same time. This was through the command of Allah.

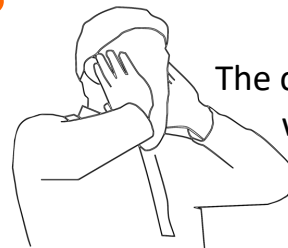

The call for prayer was made and soon the prophets were gathered for salah. Angel Jibrael عليه السلام took Prophet Muhammad ﷺ to the front to lead the prayer as Imam.

They spent a short time in Masjid Al-Aqsa before they ascended into the heavens.



While still in Masjid Al-Aqsa, the Angel Jibrael عليه السلام offered our Prophet Muhammad ﷺ two cups - One was filled with milk, the other with wine.

Prophet Muhammad ﷺ chose and drank the milk.

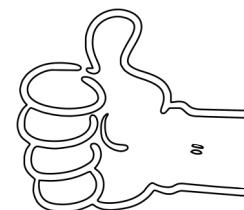

Angel Jibrael عليه السلام then said to him:

“Thanks be to God, who guided you to the fitrah; if you had taken the wine, your followers would have gone astray.”

The journey through the heavens is the next part of our wonderful story. It will be continued next time, In-Sha-Allah

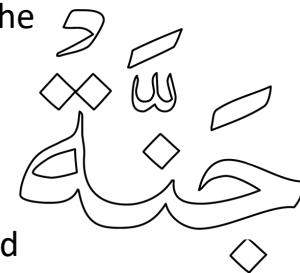

**Fitrah is the natural state in which a person is born. This guides a person to the truth and Allah.**





# Activity 4. MASJID AL-AQSA

My Name is: \_\_\_\_\_

Dome of the Rock

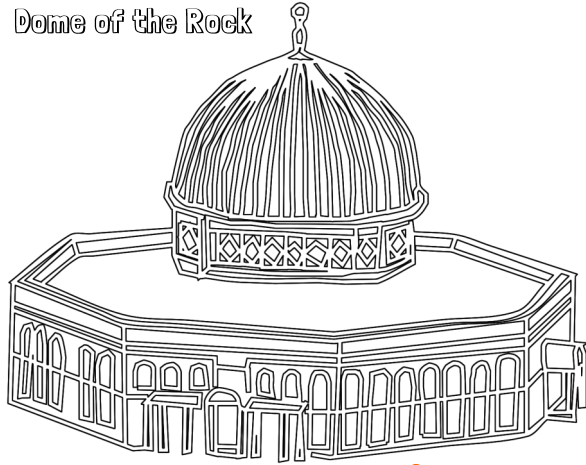

Dome of Ascension

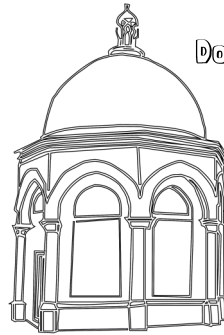

Sulaiman's Monument

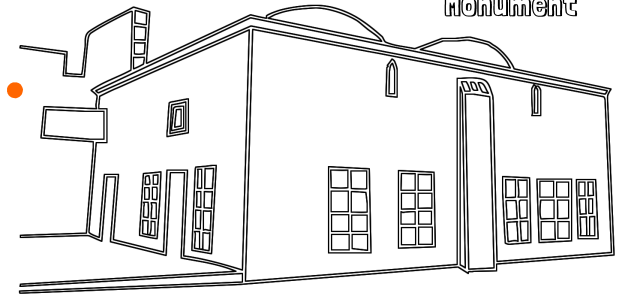

Masjid Al-Aqsa is the **third** most holy place in Islam.

It is located in the city of Jerusalem.

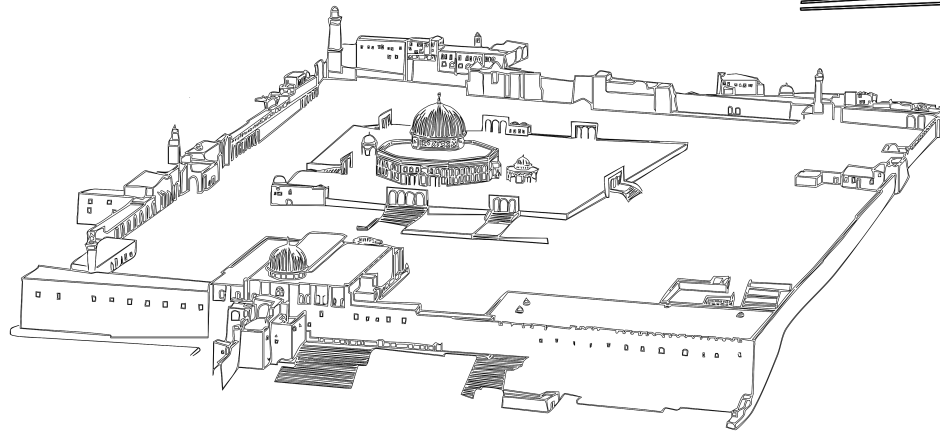

- Masjid Al Aqsa is
- not a single
- Masjid but
- there are **44**
- main buildings
- in the Al-Aqsa
- Sanctuary



Masjid Qibly

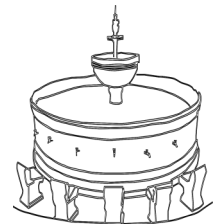
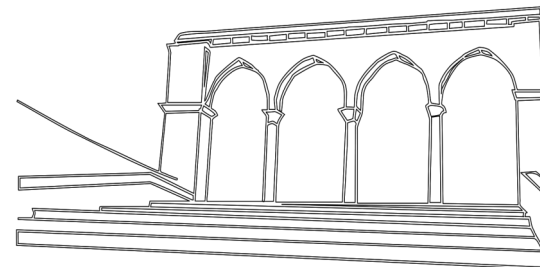

Fountains, Wells  
Archways,  
Schools...

# LOVE FOR MASJID AL-AQSA

Masjid Al-Aqsa is the **Second Masjid** built by Prophet Adam عليه السلام and also the **first Qibla**. Prophet Muhammad صلى الله عليه وسلم spoke of it with great love and fondness.

## VIRTUE



".... a prayer in Al-Aqsa Sanctuary is worth 500 times more reward than anywhere else" (Bayhaqi)

## VISIT

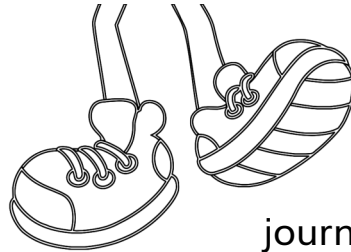

"Do not undertake a journey to visit any Masjid, but three: this Masjid of mine, Masjid Al-Haram and Masjid Al-Aqsa" (Sahih Muslim)

## BLESSED

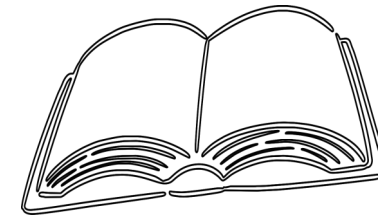

Allah tells us in the Qur'an that the precinct (the area within the walls) is blessed.



Our Prophet Muhammad صلى الله عليه وسلم had **great love** for Masjid Al-Aqsa. He used to remind his companions رضي الله عنهم how **special and blessed** Masjid Al-Aqsa is. Our Prophet صلى الله عليه وسلم also encouraged people to **go to visit and pray in** Masjid Al-Aqsa.



# VISITING MASJID AL-AQSA

I love Masjid Al-Aqsa because....

WHY IS AL-AQSA SPECIAL TO YOU?

Draw different ways we can travel to **Masjid Al-Aqsa** so we can put our Ihram on for Hajj.

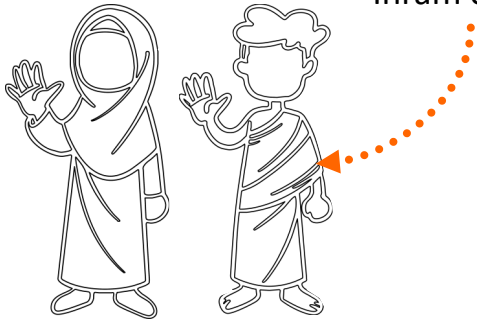

**"If anyone puts on ihram for Hajj or Umrah from Masjid al-Aqsa and then proceeds to the sacred Masjid (Ka'bah), their past and future sins will be forgiven, or will be guaranteed Jannah." (Abu Dawud)**



**Activity:** Draw in the missing buildings and write their names next to them

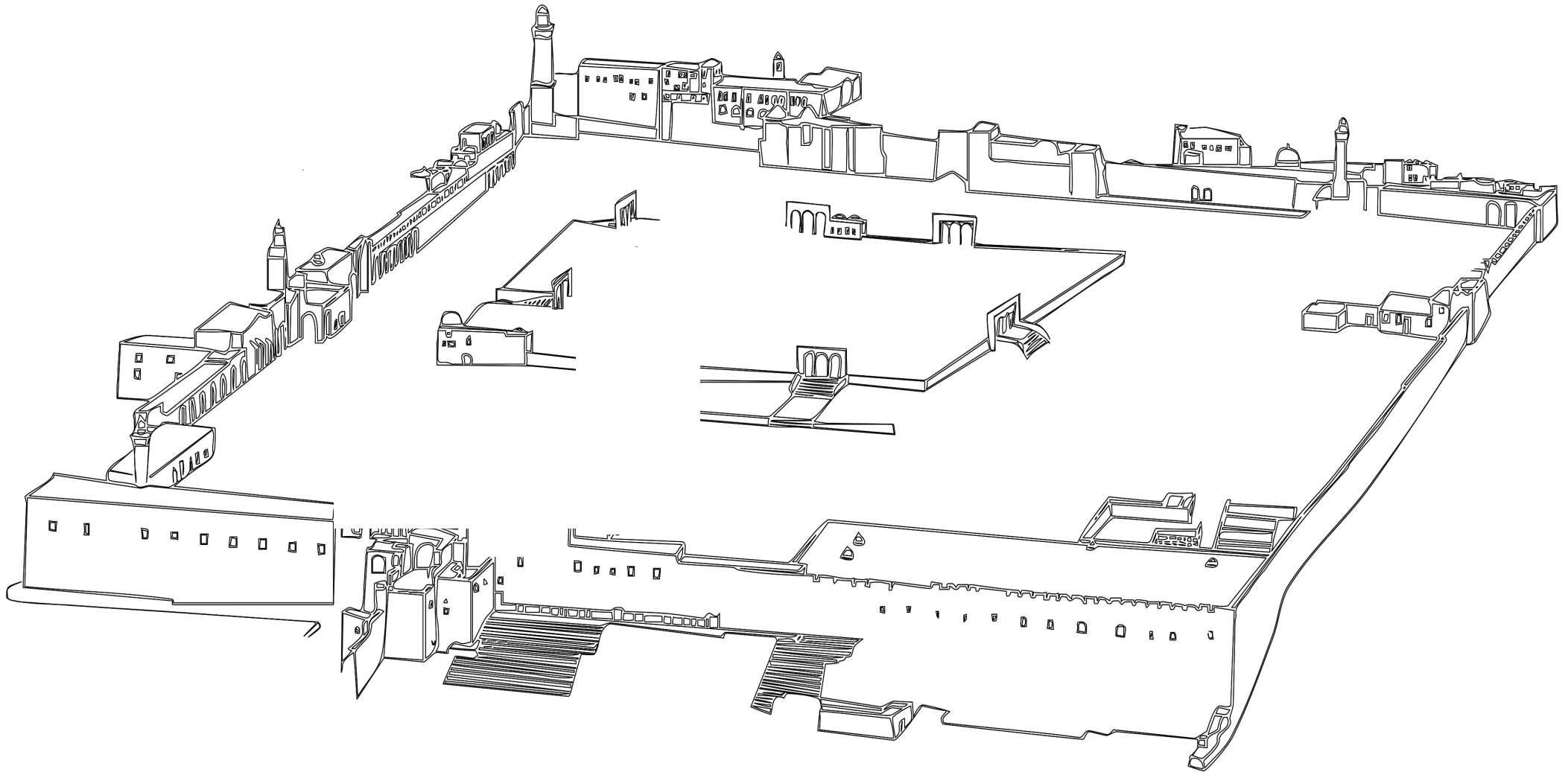

**The whole land of the Masjid Al-Aqsa sanctuary and its buildings are precious and blessed.**

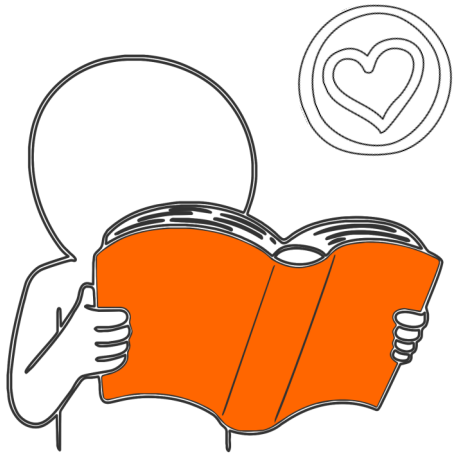

## History of Masjid Al-Aqsa

Prophet Adam ﷺ was commanded by Allah to build the Ka'bah. Forty years later, Prophet Adam ﷺ was told to build Masjid Al-Aqsa.

These were the first two sacred places of worship dedicated to the worship of Allah.

Over time, people forgot about Allah and stopped worshipping Him. They began to worship idols and other things. Both Masajids became ruins.

After a long time, Allah sent another great Prophet, Ibrahim ﷺ who rebuilt the Ka'bah and Masjid Al-Aqsa. He rebuilt the Ka'bah on the original foundations and also rebuilt Masjid Al-Aqsa in its original place.

Ibrahim ﷺ had rebuilt the Ka'bah with his first son, Ismael ﷺ. Ismael ﷺ had been living here with his mother since he was a baby. Allah had gifted them Zamzam water and a town called Makkah had developed here.

Ibrahim's second son, Ishaq ﷺ helped rebuild Masjid Al-Aqsa. Allah sent many prophets to Masjid Al-Aqsa to look after it and pray there.

So there were communities in both these sacred places, praying to Allah.

Prophet Yusuf ﷺ was a son of Prophet Yaqub ﷺ. As a youngster, Yusuf ﷺ had been thrown into the well by his brothers. He had been rescued by travellers and taken to Egypt. He was sold into slavery then went to prison as an innocent man. Later on, he was given an important role in Egypt during the difficult years of famine.

During this time, his brothers came to Egypt for food and supplies. Yusuf ﷺ forgave them and soon his brothers and father came and settled in Egypt.

As time went on, there was no one to look after Masjid Al-Aqsa and pray in it. Soon it became a ruin and forgotten about. The people that

had lived there from the earliest time, the Palestinians, continued to live on these lands.

After many years, the political leader of Egypt called the Pharaoh became angry with the offspring of Yaqub ﷺ, the Jews. He made them into slaves and forced them to work for him. The Pharaoh was a very cruel tyrant.

After a while, Allah sent Musa ﷺ to free the Jews and take them back to Jerusalem and Masjid Al-Aqsa.

When they got there, they refused to fight the native Palestinians who lived there. The Jews spent forty years in the desert.

Soon a brave youngster, Prophet Dawud ﷺ, came and he helped to fight and take over Jerusalem. He then started to work very hard to rebuild Masjid Al-Aqsa.

After Dawud ﷺ passed away, his son, Prophet Sulaiman ﷺ finished rebuilding Masjid Al-Aqsa. Sulaiman ﷺ was a great prophet and Allah had given him the power to control animals and Jinn. He used the Jinn to help him build Masjid Al-Aqsa.

Many years passed with people praying and looking after Masjid Al-

Aqsa. There were many great prophets including Prophet Isa ﷺ during this time.

After Prophet Isa's time, Masjid Al-Aqsa was destroyed by the Romans and again became ruins. The Romans used Masjid Al-Aqsa as a dumping ground for rubbish.

The Romans banned the Jews from entering Jerusalem for many centuries.

When Prophet Muhammad ﷺ came, he advised the Muslims to look after Masjid Al-Aqsa, to protect it, and pray in it.

A few years after Prophet Muhammad ﷺ passed away, the Sahabah went to Jerusalem and took over it. They cleaned the rubbish from the grounds of Masjid Al-Aqsa and built a Masjid on the grounds.

The Muslims were kind-hearted and allowed the banished Jews to come into Jerusalem. The Christians were also allowed to live and worship in Jerusalem.

Recently, it has been very hard for the Muslims in Jerusalem but they still try hard to pray in Masjid Al-Aqsa and look after it.



# Activity 5. Al-Aqsa to Jannah

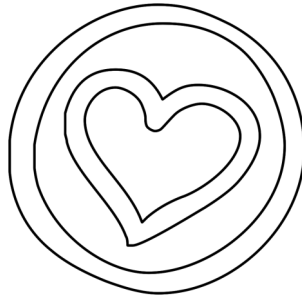
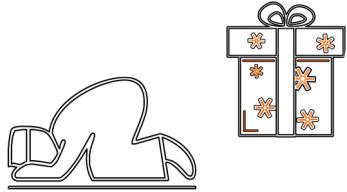

My Name is:

From Masjid Al-Aqsa,  
Our Prophet Muhammad ﷺ  
ascended into the heavens  
accompanied by Angel Jibrael  
جبرائيل.  
This part of the journey is  
known as Al-Miraj.

جَنَّة

As Prophet Muhammad ﷺ and Angel Jibrael جبرائيل ascended, they met angels and prophets at each heaven.

Finally, they reached the Lote tree which marks the furthest boundary.

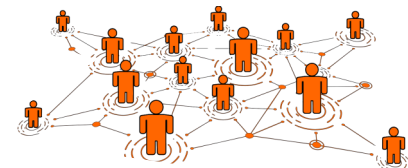
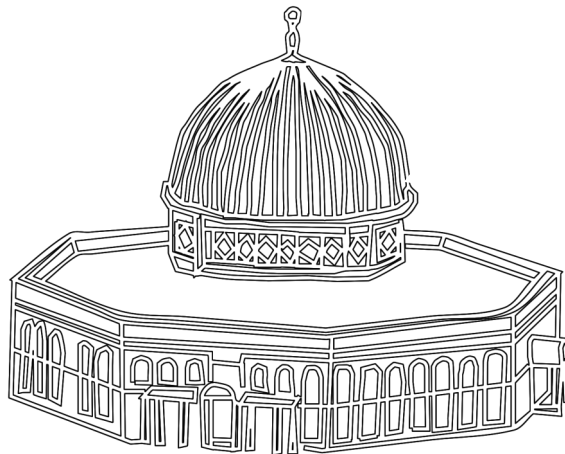
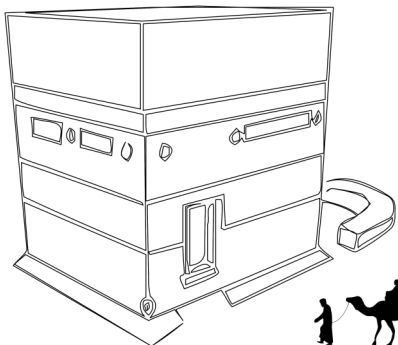

1

2

3

4

5

6

7

# Al-Miraj - The Ascension

Allah called his servant, Muhammad ﷺ, through the heavens into His presence and gifted the five daily prayers to his ummah.

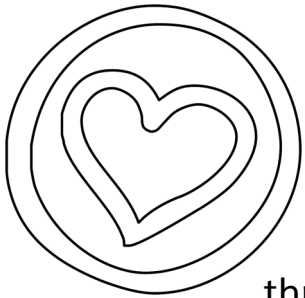

## ALLAH

After ascending through the seven heavens, Our Prophet Muhammad ﷺ was finally in the presence of Allah.

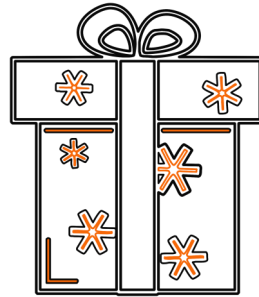

## GIFT

Our Prophet Muhammad ﷺ was given the gift of Salah (the five daily prayers). Salah was for all his Ummah to perform daily.

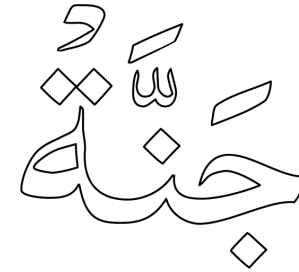

## TOURING

Through the journey, Prophet Muhammad ﷺ saw Jannah and Jahanam. He also saw the angels making tawaf around the Bait-ul Ma'mur - the Ka'bah in the sky.



Prophet Muhammad ﷺ and Angel Jibrael ﷺ ascended through the heavens until they reached the Lote tree ( Sidratul Muntaha ). This marks the place where even Angel Jibrael ﷺ could not pass. Prophet Muhammad ﷺ continued on his own to the presence of Allah.



# People and Places

Our Prophet ﷺ ascended through the Seven heavens and at each heaven met different Prophets.

- 7 Ibrahim عليه السلام
- 6 Musa عليه السلام
- 5 Haroon عليه السلام
- 4 Idris عليه السلام
- 3 Yusuf عليه السلام
- 2 Isa عليه السلام & Yahya عليه السلام
- 1 Adam عليه السلام

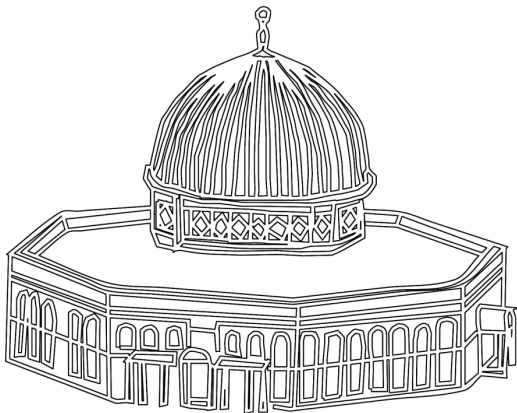

Find the names of people and places we have come across

Prophet Ibrahim عليه السلام was near the Bait-ul Ma'mur which is a Ka'bah to the inhabitants of the sky. Every day 70,000 angels come and do tawaf there.

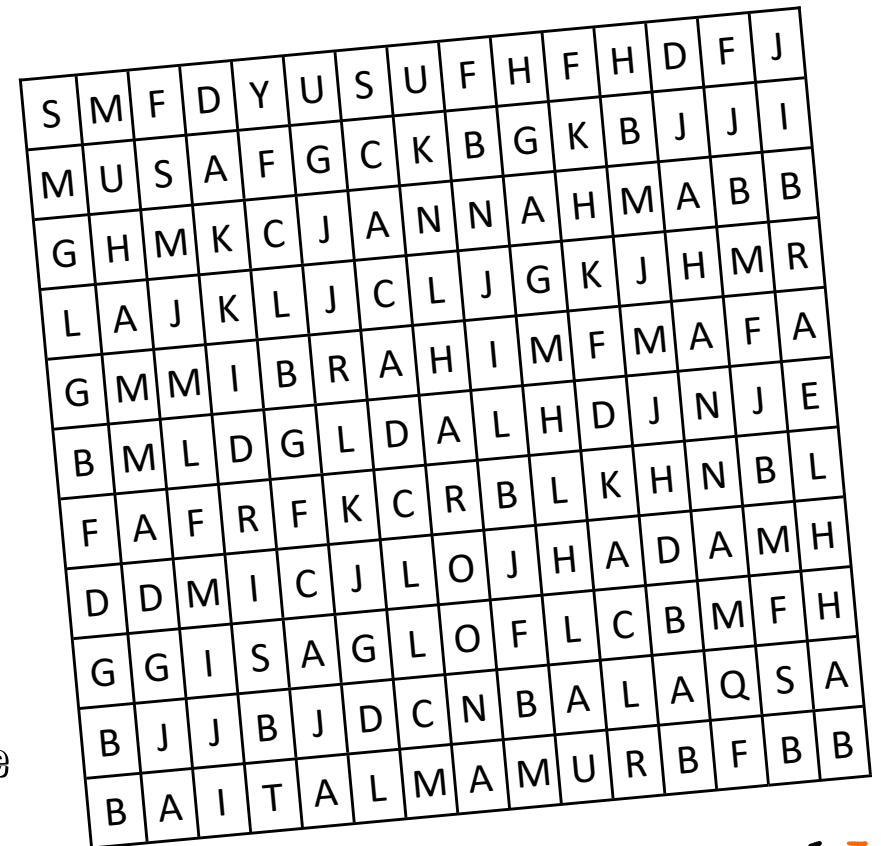



# The Journey Back

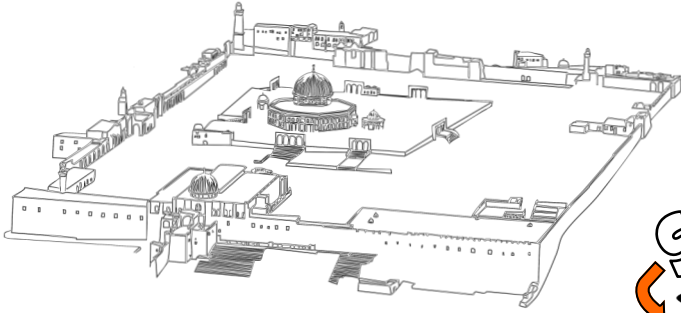

Our Prophet Muhammad ﷺ came back to Masjid Al-Aqsa where he mounted the Buraq and returned back to Makkah.

On the way, he saw caravans in the desert heading towards Makkah. He later described these caravans to the people of Makkah.

The people of Makkah were amazed when they saw those exact caravans arrive in Makkah many days later.

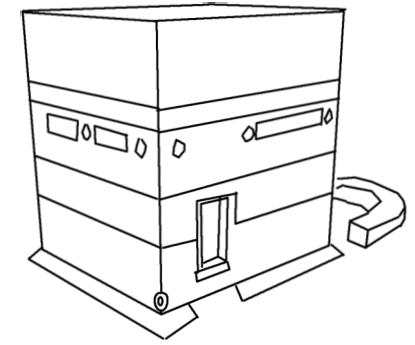
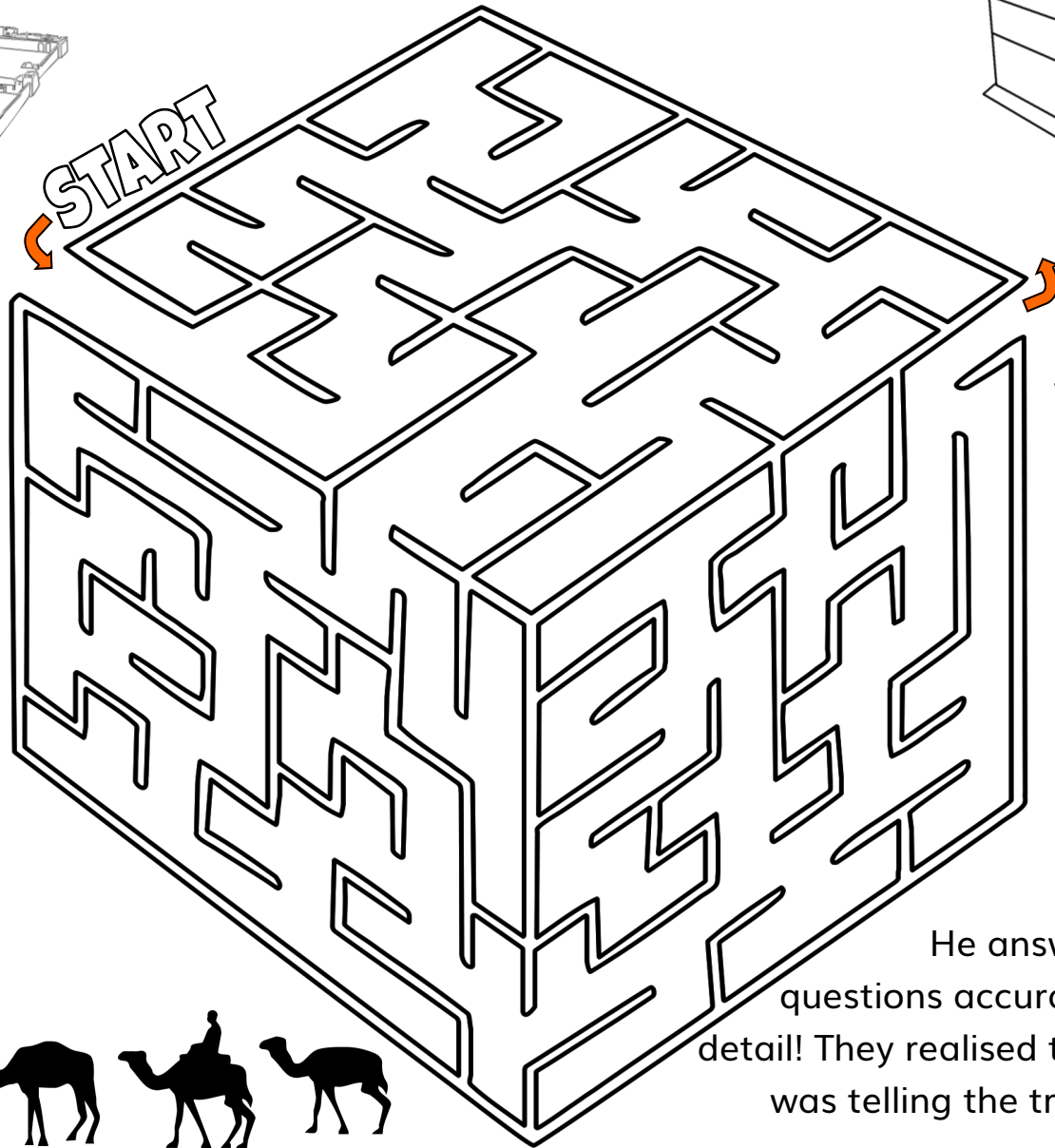
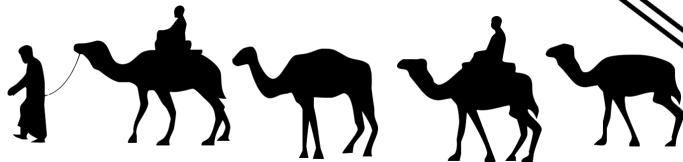

The people of Makkah were amazed when they heard about this miraculous Journey. They asked Prophet Muhammad ﷺ lots of questions about Masjid Al-Aqsa.

He answered all their questions accurately and in great detail! They realised that Muhammad ﷺ was telling the truth.

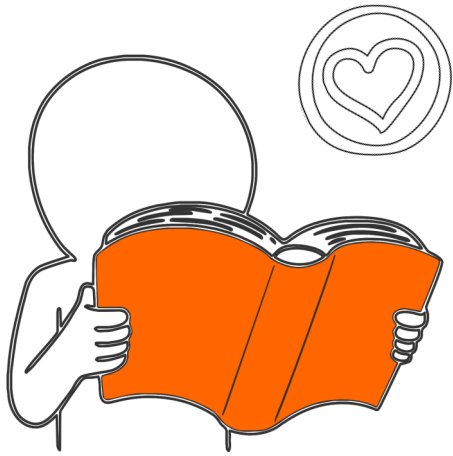

## AL-MIRAJ

After praying in Masjid Al-Aqsa with all the prophets, Prophet Muhammad ﷺ and Angel Jibrael ﷺ continued their journey.

As they ascended through the heaven, they were met at different stages of heaven by angels. The angels questioned them before letting them enter. They also met different prophets in each heaven.

After meeting Ibrahim ﷺ, in the seventh heaven, they continued the journey until they reached the Lote tree (Sidratul Muntaha).

The Lote tree is a vast tree of indescribable beauty! It has huge leaves and delicious fruits. It represents the furthest boundary.



Jibrael ﷺ was not permitted to pass this point, so Muhammad ﷺ went on the rest of the journey on his own.

Prophet Muhammad ﷺ continued until he reached the throne of Allah. It was in this meeting that Allah gifted him with fifty salah.

On his return journey through the heavens, Musa ﷺ advised him that fifty salah was too many for the people. He advised our Prophet ﷺ to go back to Allah to have it reduced.

Our Prophet went back to Allah, and the Salah was reduced to forty-five.

Again Musa ﷺ advised our Prophet ﷺ to have the Salah reduced. This happened several times until it was reduced to five daily Salah.

After arriving back at Masjid Al-Aqsa, Prophet Muhammad ﷺ again mounted the Buraq and continued the return journey to Makkah.

He saw the caravans travelling to Makkah, their camels laden with goods to sell at the markets.

When Prophet Muhammad ﷺ returned, he told the people about

his journey to Masjid Al-Aqsa. It had only taken a very short time.

The people of Makkah were surprised, and some even mocked Muhammad ﷺ about this journey. Abu Jahl, his uncle, who was an enemy of Islam, was overjoyed because he could use this to taunt our beloved Nabi ﷺ.

He knew that no one had travelled to Masjid Al-Aqsa so quickly. It was a journey that took many weeks on camels, not a small part of a night!

Some people went to Abu Bakr ؓ, who was a great Sahabi and a good friend of Prophet Muhammad ﷺ. They hoped to make fun of Abu Bakr ؓ as they told him the story of this amazing journey to Masjid Al-Aqsa.

Abu Bakr ؓ told them that if Muhammad ﷺ said this, then of course it was true. He knew that Prophet Muhammad ﷺ was trustworthy and always spoke the truth!

Abu Bakr ؓ was given the title Al-Siddiq, the truthful, after this.

The people knew that Muhammad ﷺ had never been to Masjid Al-Aqsa before in his life. They asked him

many questions about Masjid Al-Aqsa.

They asked him to describe Masjid Al-Aqsa and asked him other questions about this sacred sanctuary.

Allah brought Masjid Al-Aqsa before our Prophet's eyes, as if he was looking at it just now. Prophet Muhammad ﷺ described Masjid Al-Aqsa in perfect detail.

The people of Makkah were amazed, unknown to them they had just witnessed another miracle!

Prophet Muhammad ﷺ also told them about the caravans that were coming to Makkah soon. He described the content of one of the caravans, even describing the camels the caravans were using.

A few days later, when the caravans began to arrive, they were amazed because they were precisely as Muhammad ﷺ had described them.



In their hearts, they had always known that Muhammad ﷺ was a true prophet of Allah!

